

IMPERIAL ARMOUR VOLUME 1 IMPERIAL GUARD & IMPERIAL NAVY

RULES UPDATE (Version 1.1)

This document is an update to all the rules in our Imperial Armour Volume 1 book. Given the changes to the Warhammer 40,000 rules, the arrival of Apocalypse and the new Imperial Guard codex, the rules in the book are a little out of date. This document brings the rules into line with the new codex and were appropriate Apocalypse, with the overall aim of having one set of rules for each vehicle, regardless of which game you are playing.

This update is split into two sections the first being changes to the vehicle entries in the book, and the second being an updated Armoured Battlegroup army list. Please refer to the Imperial Guard codex for other pertinent special rules and weapon profiles used here.

LEMAN RUSS150 PTS

	Armour			
	BS	Front	Side	Rear
Leman Russ	3	14	13	10

Unit Type:

- Vehicle (Tank)

Special Rules:

- Lumbering Behemoth

Weapons and equipment:

- Battle cannon
- Heavy bolter
- Searchlight
- Smoke launcher

Lumbering Behemoth
 A Leman Russ that moved at combat speed or remained stationary can fire its turret weapon in addition to any other weapons it is usually allow to fire (even if the turret is ordnance!). However, a Leman Russ travelling at cruising speed can only move up to D6+6" – roll every time it moves at this speed.

Options:

- A Leman Russ may replace its heavy bolter with:
 - Heavy flamerfree
 - Lascannon+15 pts
- A Leman Russ model may take a pair of sponsons armed with:
 - Heavy bolters or heavy flamers+20 pts
 - Multi-meltas+30 pts
 - Plasma cannons+40 pts
- A Leman Russ may take any of the following:
 - Pintle-mounted heavy stubber or storm bolter ...+10 pts
 - Hunter-killer missile+10 pts
 - Dozerblade+10 pts
 - Extra armour+15 pts
 - Camo-netting+20 pts

LEMAN RUSS DEMOLISHER165 PTS

	Armour			
	BS	Front	Side	Rear
Leman Russ Demolisher	3	14	13	11

Unit Type:

- Vehicle (Tank)

Special Rules:

- Lumbering Behemoth

Weapons and equipment:

- Demolisher siege cannon
- Heavy bolter
- Searchlight
- Smoke launcher

Lumbering Behemoth
 A Leman Russ that moved at combat speed or remained stationary can fire its turret weapon in addition to any other weapons it is usually allow to fire (even if the turret is ordnance!). However, a Leman Russ travelling at cruising speed can only move up to D6+6" – roll every time it moves at this speed.

Options:

- A Leman Russ Demolisher may replace its heavy bolter with:
 - Heavy flamerfree
 - Lascannon+15 pts
- A Leman Russ Demolisher may take a pair of sponsons armed with:
 - Heavy bolters or heavy flamers+20 pts
 - Multi-meltas+30 pts
 - Plasma cannons+40 pts
- A Leman Russ Demolisher may take any of the following:
 - Pintle-mounted heavy stubber or storm bolter ...+10 pts
 - Hunter-killer missile+10 pts
 - Dozerblade+10 pts
 - Extra armour+15 pts
 - Camo-netting+20 pts

LEMAN RUSS VANQUISHER155 PTS

		Armour		
Leman Russ	BS	Front	Side	Rear
Vanquisher	3	14	13	10

Unit Type:

- Vehicle (Tank)

Special Rules:

- Lumbering Behemoth
- Co-axial weapon (if taken)

Weapons and equipment:

- Vanquisher battle cannon
- Heavy bolter
- Searchlight
- Smoke launcher

Options:

- A Leman Russ Vanquisher may replace its heavy bolter with:
 - Heavy flamerfree
 - Lascannon+15 pts
- A Leman Russ Vanquisher may take a pair of sponsons armed with:
 - Heavy bolters or heavy flamers+20 pts
 - Multi-meltas+30 pts
 - Plasma cannons+40 pts
- A Leman Russ Vanquisher may take:
 - A co-axial mounted storm bolter or heavy stubber ...+10 pts
- A Leman Russ Vanquisher may take any of the following:
 - Pintle-mounted heavy stubber or storm bolter ...+10 pts
 - Hunter-killer missile+10 pts
 - Dozerblade+10 pts
 - Extra armour+15 pts
 - Camo-netting+20 pts

<p>Lumbering Behemoth A Leman Russ that moved at combat speed or remained stationary can fire its turret weapon in addition to any other weapons it is usually allow to fire (even if the turret is ordnancel). However, a Leman Russ travelling at cruising speed can only move up to D6+6” – roll every time it moves at this speed.</p>	<p>Co-axial weapon A co-axial weapon must be fired at the same target as the main weapon (ie the weapon it is attached to), and any damage result that affects the main weapon affects them as well. If the player fires the co-axial weapon before the main weapon and scores at least one hit on the target unit, he may re-roll the to hit roll for the main weapon.</p>
--	---

LEMAN RUSS EXTERMINATOR150 PTS

		Armour		
Leman Russ	BS	Front	Side	Rear
Exterminator	3	14	13	10

Unit Type:

- Vehicle (Tank)

Special Rules:

- Lumbering Behemoth

Weapons and equipment:

- Exterminator autocannon
- Heavy bolter
- Searchlight
- Smoke launcher

Options:

- A Leman Russ Exterminator may replace its heavy bolter with:
 - Heavy flamerfree
 - Lascannon+15 pts
- A Leman Russ Exterminator may take a pair of sponsons armed with:
 - Heavy bolters or heavy flamers+20 pts
 - Multi-meltas+30 pts
 - Plasma cannons+40 pts
- A Leman Russ Exterminator may take any of the following:
 - Pintle-mounted heavy stubber or storm bolter ...+10 pts
 - Hunter-killer missile+10 pts
 - Dozerblade+10 pts
 - Extra armour+15 pts
 - Camo-netting+20 pts

<p>Lumbering Behemoth A Leman Russ that moved at combat speed or remained stationary can fire its turret weapon in addition to any other weapons it is usually allow to fire (even if the turret is ordnance!). However, a Leman Russ travelling at cruising speed can only move up to D6+6” – roll every time it moves at this speed.</p>
--

LEMEN RUSS CONQUEROR130 PTS

		Armour			
Leman Russ	BS	Front	Side	Rear	
Conqueror	3	14	13	10	

Unit Type:

- Vehicle (Tank)

Special Rules:

- Co-axial weapon

Weapons and equipment:

- Conqueror Battle Cannon with co-axial storm bolter
- Heavy bolter
- Searchlight
- Smoke launcher

Options:

- A Leman Russ Conqueror may replace its heavy bolter with:
 - Heavy flamerfree
 - Lascannon+15 pts
- Any model may take a pair of sponsons armed with:
 - Heavy bolters or heavy flamers+20 pts per model
 - Multi-meltas+30 pts per model
 - Plasma cannons+40 pts per model
- A Leman Russ may take any of the following:
 - Pintle-mounted heavy stubber or storm bolter ...+10 pts
 - Hunter-killer missile+10 pts
 - Dozerblade+10 pts
 - Extra armour+15 pts
 - Camo-netting+20 pts

Weapon	Range	Str.	AP	Type
Conqueror cannon	48"	8	3	Heavy1/Blast

Co-axial weapon
 A co-axial weapon must be fired at the same target as the main weapon (ie the weapon it is attached to), and any damage result that affects the main weapon affects them as well. If the player fires the co-axial weapon before the main weapon and scores at least one hit on the target unit, he may re-roll the scatter dice for the main weapon.

Note: The Leman Russ Conqueror does not have the Lumbering Behemoth special rule.

LEMEN RUSS EXECUTIONER190 PTS

		Armour			
Leman Russ	BS	Front	Side	Rear	
Executioner	3	14	13	11	

Unit Type:

- Vehicle (Tank)

Special Rules:

- Lumbering Behemoth

Weapons and equipment:

- Executioner plasma cannon
- Heavy bolter
- Searchlight
- Smoke launcher

Options:

- A Leman Russ Executioner may replace its heavy bolter with:
 - Heavy flamerfree
 - Lascannon+15 pts
- A Leman Russ Executioner model may take a pair of sponsons armed with:
 - Heavy bolters or heavy flamers+20 pts
 - Multi-meltas+30 pts
 - Plasma cannons+40 pts
- A Leman Russ Executioner may take any of the following:
 - Pintle-mounted heavy stubber or storm bolter ...+10 pts
 - Hunter-killer missile+10 pts
 - Dozerblade+10 pts
 - Extra armour+15 pts
 - Camo-netting+20 pts

Lumbering Behemoth
 A Leman Russ that moved at combat speed or remained stationary can fire its turret weapon in addition to any other weapons it is usually allow to fire (even if the turret is ordnance!). However, a Leman Russ travelling at cruising speed can only move up to D6+6" – roll every time it moves at this speed.

DESTROYER TANK HUNTER160 PTS

		Armour			
Destroyer	BS	Front	Side	Rear	
	3	14	13	10	

Unit Type:

- Vehicle (Tank)

Special Rules:

- None

Weapons and equipment:

- Laser Destroyer
- Searchlight
- Smoke launcher

Options:

- A Destroyer Tank Hunter may take any of the following:
 - Pintle-mounted heavy stubber or storm bolter ...+10 pts
 - Hunter-killer missile+10 pts
 - Dozerblade+10 pts
 - Extra armour+15 pts
 - Camo-netting+20 pts

Weapon	Range	Str.	AP	Type
Laser Destroyer	72"	10	2	Ordnance 1

THUNDERER140 PTS

	BS	Armour		
		Front	Side	Rear
Thunderer	3	14	13	11

Unit Type:

- Vehicle (Tank)

Special Rules:

- None

Weapons and equipment:

- Demolisher cannon
- Searchlight
- Smoke launcher

Options:

- A Thunderer may take any of the following:
 - Pintle-mounted heavy stubber or storm bolter+10 pts
 - Hunter-killer missile+10 pts
 - Dozerblade+10 pts
 - Extra armour+15 pts
 - Camo-netting+20 pts

BANEBLADE500 PTS

	BS	Armour		
		Front	Side	Rear
Baneblade	3	14	13	12

Unit Type:

- Vehicle (Super-heavy tank)

Structure Points:

- 3

Special Rules:

- None

Weapons and equipment:

- Turret mounted Baneblade cannon with co-axial autocannon
- Hull mounted Demolisher cannon
- Hull mounted twin-linked heavy bolters
- Two sponsons, each with a lascannon and twin-linked heavy bolters
- Searchlight
- Smoke launchers

Options:

- A Baneblade may take any of the following:
 - Pintle-mounted heavy stubber or storm bolter10 pts
 - Hunter-killer missile10 pts
- A Baneblade may replace its two side sponsons with: extra armour plates, increasing its side armour to 14free
- A Baneblade may take two additional side sponsons, each armed with a lascannon and twin-linked heavy bolter100 pts
- A Baneblade may be upgraded to one of the following:
 - Command Tank25 pts
 - Commissariat Crew25 pts

Weapon	Range	Str.	AP	Type
Baneblade cannon	72"	9	2	Ordnance 1, 10" blast, primary weapon

Command Tank

A high ranking officer is using the Baneblade as a mobile field HQ. All Imperial Guard units within 24" of a Baneblade command take may re-roll failed Morale checks.

Commissariat Crew

A Baneblade may be upgraded to carry members of the Commissariat, who use the Baneblade as a platform to urge the men on to more heroic deeds. Any Imperial Guard unit within 12" of a Baneblade with Commissariat crew count their leadership value as 10.

SHADOWSWORD450 PTS

	BS	Armour		
		Front	Side	Rear
Shadowsword	3	14	13	12

Unit Type:

- Vehicle (Super-heavy tank)

Structure Points:

- 3

Special Rules:

- None

Weapons and equipment:

- One Volcano cannon
- Two sponsons, each with a lascannon and twin-linked heavy bolters
- Searchlight
- Smoke launchers

Options:

- A Shadowsword may take any of the following:
 - Pintle-mounted heavy stubber or storm bolter10 pts
 - Hunter-killer missile10 pts
- A Shadowsword may replace its sponson lascannons - with targeters (+1BS)free
- A Shadowsword may replace its two side sponsons with:
 - extra armour plates, increasing its side armour to 14 ..free
- A Shadowsword may take:
 - two additional side sponsons, each armed with a lascannon and twin-linked heavy bolter100 pts
- A Shadowsword may take a:
 - hull-mounted twin-linked heavy bolter25 pts
- A Shadowsword may be upgraded to a
 - Command Tank25 pts

Weapon	Range	Str.	AP	Type
Volcano cannon	120"	D	2	Ordnance 1, 5" blast, primary weapon

Command Tank

A high ranking officer is using the Shadowsword as a mobile field HQ. All Imperial Guard units within 24" of a Shadowsword command take may re-roll failed Morale checks.

STORMBLADE450 PTS

	Armour			
	BS	Front	Side	Rear
Stormblade	3	14	13	12

Unit Type:

- Vehicle (Super-heavy tank)

Structure Points:

- 3

Special Rules:

- None

Weapons and equipment:

- Plasma Blastgun
- Two sponsons armed with a lascannon and twin-linked heavy bolters
- Hull mounted heavy bolter
- Searchlight
- Smoke launchers

Command Tank

A high ranking officer is using the Stormblade as a mobile field HQ. All Imperial Guard units within 24" of a Stormblade command take may re-roll failed Morale checks.

Options:

- A Stormblade may take any of the following:
 - Pintle-mounted heavy stubber or storm bolter10 pts
 - Hunter-killer missile10 pts
- A Stormblade may replace its two side sponsons with:
 - extra armour plates, increasing its side armour to 14 ..free
- A Stormblade may take:
 - two additional side sponsons, each armed with a lascannon and twin-linked heavy bolter100 pts
- A Stormblade may be upgraded to one of the following:
 - Command Tank25 pts

Weapon	Range	Str.	AP	Type
Plasma Blastgun (Rapid)	72"	8	2	Ordnance 2, 7" blast, primary weapon
(Full)	96"	10	2	Ordnance 1, 10" blast, primary weapon

STORMSWORD450 PTS

	Armour			
	BS	Front	Side	Rear
Stormsword	3	14	13	12

Unit Type:

- Vehicle (Super-heavy tank)

Structure Points:

- 3

Special Rules:

- None

Weapons and equipment:

- Stormsword cannon
- Hull-mounted heavy bolter
- Two sponsons, each with one heavy flamer and twin-linked heavy bolters or twin-linked heavy flamers
- Searchlight
- Smoke launchers

Command Tank

A high ranking officer is using the Stormsword as a mobile field HQ. All Imperial Guard units within 24" of a Stormsword command take may re-roll failed Morale checks.

Options:

- A Stormsword may take any of the following:
 - Pintle-mounted heavy stubber or storm bolter10 pts
 - Hunter-killer missile10 pts
- A Stormsword may replace its sponson heavy flamer with:
 - Lascannon20 pts
- A Stormsword may replace its two side sponsons with:
 - extra armour plates, increasing its side armour to 14 ..free
- A Stormsword may take:
 - two additional side sponsons, each armed with a lascannon and twin-linked heavy bolter100 pts
- A Stormsword may be upgraded to one of the following:
 - Command Tank25 pts

Weapon	Range	Str.	AP	Type
Stormsword cannon	36"	10	1	Ordnance 1, 10" blast, primary weapon, no cover save allowed

CHIMERA55 PTS

	Armour			
	BS	Front	Side	Rear
Chimera	3	12	10	10

Unit Type:

- Vehicle (tank)

Transport Capacity:

- 12 models

Special Rules:

- Amphibious
- Mobile Command Vehicle

Weapons and equipment:

- Multi-laser
- Heavy bolter
- Searchlight
- Smoke launcher

Mobile Command Vehicle:
An officer embarked within a Chimera may still issue orders to squads. Measure ranges and line of sight from any point of the Chimera's hull.

Options:

- Replace multi-laser with:
 - Heavy flamerfree
 - Heavy bolterfree
 - Autocannon5 pts
 - Twin-linked heavy bolters10 pts
- Replace Heavy bolter with:
 - Heavy flamerfree
- Take any of the following:
 - Pintle-mounted storm bolter or heavy stubber10 pts
 - Hunter-killer missile10 pts
 - Dozerblade10 pts
 - Extra armour15 pts
 - Camo-netting20 pts

Fire points:

- 5 models may fire from the Chimera's top hatch.

SALAMANDER SCOUT55 PTS

	Armour			
	BS	Front	Side	Rear
Salamander	3	12	10	10

Unit Type:

- Vehicle (tank, open-topped)

Weapons and equipment:

- Autocannon
- Heavy Bolter
- Searchlight
- Smoke Launcher

Special Rules:

- Overcharged Engines

Options:

- Take the following:
 - Pintle-mounted heavy stubber or storm bolter10 pts
 - Hunter-killer missile10 pts
 - Dozerblade10 pts
 - Extra armour15 pts
 - Camo-netting20 pts

Overcharged Engines
The Salamander is fitted with a specially modified engine. These engines allow Salamanders to attempt to go faster but at risk of stalling the engines. You may declare that a Salamander scout is going to use its overcharged engines in any Movement phase just before you move.

Roll a D6. On a roll of a 1 the engine stalls and the vehicle may not move at all this turn. On a 2-3 the boosters fail to kick in. the vehicle moves normally. On a roll of 4-6 the boosters work and vehicle is treated as a fast vehicle for the entire turn.

SALAMANDER COMMAND55 PTS

	BS	Armour		
		Front	Side	Rear
Salamander	3	12	10	10

Unit Type:

- Vehicle (Tank, Open-topped)

Weapons and equipment:

- Heavy flamer
- Heavy bolter
- Searchlight
- Smoke launcher
- Surveyor

Special Rules:

- Mobile Command Vehicle
- Surveyor

Options:

- A Salamander Command may replace its heavy flamer with:
 - Heavy bolterfree
- A Salamander Command may take any of the following:
 - Pintle-mounted heavy stubber or storm bolter+10 pts
 - Hunter-killer missile+10 pts
 - Dozerblade+10 pts
 - Extra armour+15 pts
 - Camo-netting+20 pts

Surveyor

Each Salamander Command vehicle is fitted with a driver's surveyor. At the start of a game, enemy infiltrators may not be set-up within 4D6" of a Salamander Command vehicle. Roll before any enemy infiltrators are deployed.

Mobile Command Vehicle

The Salamander Command may still issue orders just like a Company Commander. It may issue 2 orders to units (not vehicles) within 12". It may issue the following orders: Bring it Down!, Fire on My Target!, Get back in the fight. First rank, Fire!, second rank, FIRE!, Incoming! And Move, move, move orders. It always counts as having a vox.

As a command vehicle it may also spot for an artillery strike.

TROJAN35 PTS

	BS	Armour		
		Front	Side	Rear
Trojan	3	10	10	10

Unit Type:

- Vehicle (Tank)

Weapons and equipment:

- Heavy bolter
- Searchlight
- Smoke launcher

Special Rules:

- Towing vehicle
- Amphibious

Options:

- A Trojan may replace its heavy bolter with:
 - Heavy flamerfree
- A Trojan may take any of the following:
 - Pintle-mounted heavy stubber or storm bolter+10 pts
 - Hunter-killer missile+10 pts
 - Dozerblade+10 pts
 - Extra armour+15 pts
 - Camo-netting+20 pts

Towing Vehicle

The Trojan's main role is as a towing vehicle for supply trailers, weapon platforms and artillery pieces. To unlimber a towed gun and set it up ready to fire takes an entire turn. The Trojan cannot move or fire in the turn it wishes to unlimber, and the towed gun may not fire in that turn either.

To limber a gun also takes a complete turn, in which the Trojan cannot move or fire, and the gun cannot fire either.

Amphibious

Trojans are amphibious vehicles that can move through water. It may treat water features (such as rivers, streams, lakes etc) as open terrain when they move. If a Trojan is towing anything it no longer counts as amphibious.

ATLAS 85 PTS

	Armour			
	BS	Front	Side	Rear
Atlas	3	14	13	10

Unit Type:

- Vehicle (tank)

Special Rules

- Recovery vehicle
- Repair

Weapons and equipment:

- Heavy Bolter
- Searchlight
- Smoke launchers

Options:

- An Atlas may take any of the following:
 - Pintle-mounted heavy stubber or storm bolter10 pts
 - Hunter-killer missile10 pts
 - Dozerbalde10 pts
 - Extra armour15 pts
 - Camo-netting20 pts

<p>Recovery Tank The Atlas can drag any destroyed or immobilised vehicle (friend or foe) that it starts the turn in contact with. Both vehicles may move up to D6" and must remain in contact with each other. Neither vehicle may shoot in the same turn that they are towing or being towed in. The Atlas can be used to move a completely destroyed vehicle out of the way if it is blocking movement, or move a vehicle that is immobilised in difficult terrain out of the terrain so it can move again.</p>	<p>Repair If the Atlas starts the turn in contact with a damaged vehicle, in the Shooting phase it can attempted to repair it instead of shooting or towing. Roll a D6. If the result is a 6 then a weapon destroyed or Immobilised result (owning player's choice) is repaired. If a weapon destroyed result is repaired, that weapon can then be fired in the following Shooting phase.</p>
--	--

CYCLOPS REMOTE CONTROL DEMOLITION VEHICLE 25 PTS

	Armour			
	BS	Front	Side	Rear
Cyclops	-	10	10	10

	WS	BS	S	T	W	I	A	Ld	Sv
Operator	3	3	3	3	1	3	1	7	5+

Unit Composition:

- 1-3 Cyclops each with 1 Operator

Special Rules

- Remote control
- Demo-charge
- Operator
- Damage

Weapons and equipment:

- Demolition Charge
- Lasgun (operator only)

Unit Type:

- Vehicle

<p>Remote Control The Cyclops is remote controlled. It may move to within 1" of an enemy model in the Movement phase.</p> <p>Operator The operator is a single Death Korps Guardsman. He guides the Cyclops to its target by remote control. The Cyclops cannot function more than 48" away from the operator. If they become separated, the Cyclops simply stops and can do nothing until the operator is back within 48". If the operator is killed, the Cyclops can do nothing (including detonate).</p>	<p>Demo-Charge The Cyclops carries a demolition charge that detonates when the vehicle reaches its target. In the Imperial Guard Shooting phase, place the template centred on the Cyclops. Do not roll for scatter. Anything under the template is hit as normal. The Cyclops is destroyed in the explosion, remove it from play. Do not halve the demo-charge's strength, it always attacks at full strength.</p> <p>Damage The Cyclops is destroyed by a glancing or penetrating hit. When rolling for armour penetration, if a weapon scores a 6 and this results in a penetrating hit against the Cyclops, the demolition charge explodes. Place the template centred on the Cyclops as if detonating as normal. Note that a roll of 6 that causes a glancing hit will cause the Cyclops to explode.</p>
---	---

SENTINEL POWERLIFTER 25 PTS

		Armour							
		WS	BS	S	F	S	R	I	A
Sentinel Powerlifter	3	3	7	10	10	10	3	2	

Unit Type:

- Walker (Open-topped)

Special Rules

- Powerlifter

Weapons and equipment:

- Powerlifter

Powerlifter
 The hydraulic pistons of the Powerlifter increase the Sentinel's strength by +2. This is already included in the profile above.

Options:

- A Sentinel Powerlifter may take any of the following:
 - Searchlight+1 pts
 - Smoke launcher+5 pts
 - Camo-netting+10 pts

BASILISK125 PTS

		Armour			
		BS	Front	Side	Rear
Basilisk	3	12	10	10	

Unit Type:

- Vehicle (Tank, open-topped)

Weapons and equipment:

- Earthshaker cannon
- Heavy Bolter
- Searchlight
- Smoke Launcher

Special Rules:

- None

Options:

- May replace its heavy bolter with:
 - Heavy flamerfree
- A Basilisk may take any of the following:
 - Enclosed Fighting Compartment15 pts
 - Pintle-mounted storm bolter or heavy stubber10 pts
 - Hunter-killer missile10 pts
 - Dozer blade10 pts
 - Extra armour15 pts
 - Camo nets30 pts

GRIFFON HEAVY MORTAR CARRIER75 PTS

		Armour			
		BS	Front	Side	Rear
Griffon	3	12	10	10	

Unit Type:

- Vehicle (Tank, open-topped)

Weapons and equipment:

- Griffon Heavy Mortar
- Heavy Bolter
- Searchlight
- Smoke Launcher

Special Rules:

- Accurate Bombardment

Accurate Bombardment
 The Griffon's lighter payload affords greater accuracy than that of larger calibre field artillery. When a Griffon fires its heavy mortar, the controlling player can re-roll the scatter dice if he wishes.

Options:

- May replace its heavy bolter with:
 - Heavy flamerfree
- A Griffon may take any of the following:
 - Enclosed fighting compartment15 pts
 - Pintle-mounted storm bolter or heavy stubber10 pts
 - Hunter-killer missile10 pts
 - Dozer blade10 pts
 - Extra armour15 pts
 - Camo nets30 pts

MEDUSA135 PTS

	Armour			
	BS	Front	Side	Rear
Medusa	3	12	10	10

Unit Type:

- Vehicle (Tank, Open topped)

Weapons and equipment:

- Medusa siege cannon
- Heavy Bolter
- Searchlight
- Smoke Launcher

Special Rules:

- None

Options:

- May replace its heavy bolter with:
 - Heavy flamerfree
- A Medusa may take any of the following:
 - Enclosed Fighting Compartment15 pts
 - Pintle-mounted storm bolter or heavy stubber10 pts
 - Hunter-killer missile10 pts
 - Dozer blade10 pts
 - Extra armour15 pts
 - Camo-netting30 pts
 - Bastion-breacher shells5 pts

HYDRA75 PTS PER MODEL

	Armour			
	BS	Front	Side	Rear
Hydra	3	12	10	10

Unit Type:

- Vehicle (Tank)

Weapons and equipment:

- Two twin-linked Hydra autocannon
- Heavy bolter
- Searchlight
- Smoke launcher
- Auto-targeting system

Special Rules:

- AA mount

Options:

- Any Hydra may replace its heavy bolter with a
 - Heavy flamerfree
- Any Hydra may take any of the following:
 - Pintle-mounted heavy stubber or storm bolter+10 pts
 - Hunter-killer missile+10 pts
 - Dozerblade+10 pts
 - Extra armour+15 pts
 - Camo-netting+20 pts

Auto-targeting system

Skimmers cannot claim the cover save gained due to moving flat out against shots fired by the Hydra. Similarly, bikes cannot claim the cover save gained due to turbo-boosting against shots fired by the Hydra.

MANTICORE145 PTS

	Armour			
	BS	Front	Side	Rear
Manticore	3	12	10	10

Unit Type:

- Vehicle (Tank)

Weapons and equipment:

- 4 Manticore missiles
- Heavy bolter
- Searchlight
- Smoke launcher

Special Rules:

- Limited Ammunition

Options:

- A Manticore may replace all 4 of its Manticore missiles with:
 - 4 Storm Eagle rockets15 pts
 - 4 Sky Eagle rocketsfree
- Any model may replace its heavy bolter with a
 - Heavy flamerfree
- Any Hydra may take any of the following:
 - Pintle-mounted heavy stubber or storm bolter+10 pts
 - Hunter-killer missile+10 pts
 - Dozerblade+10 pts
 - Extra armour+15 pts
 - Camo-netting+30 pts

Limited Ammunition

A Manticore rocket launcher typically carries a rack of four rockets. Make a note each time a rocket is fired. Once the Manticore has fired four times it has run out of ammunition. It cannot be re-armed and hence cannot fire again during the game. Note that only a single rocket can be fired each turn.

Weapon	Range	Str.	AP	Type
Manticore Missile	36-300"	9	1	Ordnance 1, 7" blast
Storm Eagle Rockets	24-120"	10	4	Ordnance barrage D3, 5" blast
Sky Eagle Rocket	120"	9	2	Ordnance1, AA mount

EARTHSHAKER PLATFORM75 PTS

	BS	Armour		
		Front	Side	Rear
Earthshaker Platform	3	11	11	11

Composition:

- 1 Earthshaker platform and 3 crew.

Weapons and equipment:

- Earthshaker cannon
- Crew:
 - Flak armour
 - Lasgun
 - Close combat weapon

Unit Type:

- Artillery (Immobile)

Special Rules:

- Immobile

Immobile
 Unless towed, an artillery platform is immobile, it cannot be moved once deployed.

Hits on the Gun: The Earthshaker is a heavy gun and has an armour value of 11 rather than 10. Any glancing or penetrating hit will still destroy the gun.

Options:

- A Earthshaker Platform may take any of the following:
 - Camo-netting+20 pts
- An Earthshaker Platform may be towed by a Trojan .+35 pts
- An Earthshaker Platform may have take:
 - Up to 3 extra crew+5 pts per model

Weapon	Range	Str.	AP	Type
Earthshaker Cannon	36-240"	9	3	Ordnance Barrage 1, Large Blast

	WS	BS	S	T	W	I	A	Ld	Sv
Crew	3	3	3	3	1	3	1	7	5+

HYDRA PLATFORM50 PTS

	BS	Armour		
		Front	Side	Rear
Hydra Platform	3	11	11	11

Unit Type:

- Artillery (Immobile)

Weapons and equipment:

- 2 twin-linked Hydra autocannons on an AA mount
- Auto-targeting systems

Immobile
 Unless towed, an artillery platform is immobile, it cannot be moved once deployed.

Options:

- A Hydra Platform may take any of the following:
 - Camo-netting+20 pts
- A Hydra Platform may be towed by a Trojan+35 pts

Weapon	Range	Str.	AP	Type
Hydra Autocannon	72"	7	4	Heavy 2

MANTICORE PLATFORM100 PTS

	BS	Armour		
		Front	Side	Rear
Manticore Platform 3	3	11	11	11

Unit Type:

- Artillery (Immobile)

Weapons and equipment:

- 4 Manticore missiles

Immobile
 Unless towed, an artillery platform is immobile, it cannot be moved once deployed.

Options:

- A Manticore may replace all 4 of its Manticore missiles with:
 - 4 Storm Eagle rockets15 pts
 - 4 Sky Eagle rocketsfree
- A Manticore Platform may take any of the following:
 - Camo-netting+20 pts
- A Manticore Platform may be towed by a Trojan ...+35 pts

Weapon	Range	Str.	AP	Type
Manticore Missile	36-300"	9	2	Ordnance 1, 7" blast
Storm Eagle Rockets	24-120"	10	4	Ordnance barrage D3, 5" blast
Sky Eagle Rockets	120"	9	2	Ordnance 1, AA mount

SENTRY GUN BATTERY15 PTS PER GUN

	BS	Armour		
		Front	Side	Rear
Tarantula	2	10	10	10

Options:

- A Tarantula may exchange its twin-linked heavy bolters for twin-linked lascannons for +10 pts per gun.

Unit Type:

- Artillery (Immobile)

Special Rules:

- Fire Modes

Weapons and equipment:

- Twin-linked heavy bolters

Firing Modes

A sentry gun can fire in one of two ways. You must decide which mode the sentry gun will be set in before the start of the game. You cannot change mode once you have decided, it remains in that mode for the rest of the game.

Point Defence Mode: The sentry gun is set up with a fixed firing arc, usually to provide covering fire over a particular area. In this mode the gun will engage enemy targets up to 36" away which are in a fixed 90° arc.

Sentry Mode: In this mode, the gun is set up to fire at any enemy which comes near, and will always turn to fire at the nearest enemy target within 18" to which it can draw a line of sight. It can fire all round.

Targeting

Which enemy unit a sentry gun will target is dictated by its armament.

- A heavy bolter equipped sentry gun will fire at the nearest non-vehicle within its firing mode.
- Lascannon equipped sentry guns will fire at the closest enemy vehicle or large monster within its firing mode.

If there is no preferred target then the nearest other target will be engaged. Only destroyed vehicles are ignored, immobilised vehicles will continue to be targeted.

TURRET EMPLACEMENT 80 PTS

	BS	Armour		
		Front	Side	Rear
Emplacement	3	13	13	12

Options:

- May replace the heavy flamer with any of the following:
 - multi-laser+5 pts
 - autocannon+5 pts
 - missile launcher+5 pts
 - twin-linked heavy bolters+10 pts
 - lascannon+10 pts
 - twin-linked autocannons+15 pts
 - plasma cannon+15 pts
 - inferno cannon+15 pts
 - multi-melta+15 pts
 - executioner plasma cannon+40 pts
 - demolisher cannon+35 pts
 - battle cannon+35 pts
 - vanquisher cannon+40 pts

Unit Type:

- Immobile

Weapons and equipment:

- Heavy flamer
- Searchlight

'212' ARETHUSA600 pts

Weisemann's tank is a standard Lucius pattern Baneblade with the following vehicle upgrades.

Special Rules:

- Veteran Crew
- Hardened Crew
- Skilled gunnery

Options:

Always has a pintle-mounted heavy bolter.

Veteran Crew

Weiseman's crew have fought through unnumbered battles and warzones, they are all veterans. Arethusa has its Ballistic skill increased to 4.

Hardened Crew

Arethusa treats all Driver stunned results as Gun Crew Shaken.

Skilled Gunnery

Nominate one of Arethusa's weapons at the start of the Shooting phase. You may re-roll any missed to hit rolls with this weapon for that turn. For blast markers, this allows you to re-roll the scatter dice. Remember you can only re-roll a single dice roll once. You may nominate a different weapon in each turn.

STEEL DOG ALPHA 230 pts

Obadiah's tank is Steel Dog Alpha, the command vehicle of the company. It is standard Gryphon IV Leman Russ Vanquisher with the following upgrades and special rules:

Weapons:

Steel Dog Alpha is armed with a vanquisher cannon with a co-axial storm bolter and a hull mounted lascannon.

Heavy Support:

Steel Dog Alpha is a Heavy Support choice for an Imperial Guard army. It is a HQ choice for an Imperial Guard Armoured Battlegroup.

Special Rules:

- Command Crew
- 'My Boys Love It!'
- Veteran Tank Hunters

Command Crew

As a Company Command vehicle, Steel Dog Alpha has its BS increased from 3 to 4.

'My Boys Love It!'

Obadiah has had his tank specially converted to carry a loud speaker system. Over this he broadcasts orders for the rest of the company and loud Varolian martial music to inspire his boys and frighten the enemy (Varolian martial music is very loud, long

and, to the untrained ear, quite painful!' When Obadiah's tank forces a Tank Shock test on an enemy unit, the unit must make the test at an additional -1 to their Leadership.

Veteran Tank Hunters

Under Obadiah's command, the crew of Steel Dog Alpha have all been through many battles and campaigns. They are all veteran Tank Hunters, and may add +1 to all its rolls for Armour penetration.

Colonel 'Snake' Stranski175 pts + cost of Chimera

Colonel Stranski leads a Company Command squad consisting of himself and four veteran guardsmen. They are mounted in a Chimera (see below). They have the same stats as a standard Command HQ from Codex: Imperial Guard.

	WS	BS	S	T	W	I	A	Ld	Sv
Col.Stranski	4	4	3	3	3	3	3	9	3+
Vet. Guardsmen	3	4	3	3	1	3	1	8	4+

Special Rules:

- Senior Officer (Stranski only)
- All guns blazing (Stranski only)

Options:

- The Chimera may take any of the normal options available to a Chimera.

Command HQ:

Stranski is armed with two plasma pistols (counts a twin-linked). One veteran guardsman has a medi-pack. One veteran guardsmen has a vox-caster. Two veteran guardsmen carry melta-guns.

HQ:

Stranski, with his squad and Chimera, are a single HQ choice for an Imperial Guard army.

Chimera:

Stranski's current Chimera is the regiment's HQ vehicle. It is a standard Chimera with the following weapons.

Weapons:

It is armed with a heavy flamer and hull mounted heavy bolter.

'All guns blazing'

Stranski likes to be in the thick of the action. Whilst riding in his Chimera, he may fire both his plasma pistols from the hatch. He can fire these in addition to any other weapons the Chimera is firing, and can fire them regardless of how far the Chimera has moved.

GRACE OF THE THRONE195 pts

Grizmund's tank is the 'Grace of the Throne', the regimental command vehicle. It is a standard Leman Russ tank with a Mars Alpha hull.

HQ:

General Grizmund in the Grace of the Throne is a HQ choice for an Imperial Guard army. He is also HQ choice for an Imperial Guard Armoured battle group.

Weapons:

Grace of the Throne is armed with a battle cannon and a hull mounted heavy bolter.

Special Rules:

- Command crew
- 'Best of the best'

Options:

- Grizmund's tank can take any options usually available to a Leman Russ tank.

Command Crew

As a regimental command vehicle, Grace of the Throne has its BS increase fro 3 to 4.

'Best of the best'

The Narmerian 1st are organised differently from other regiments. It has a core cadre of veteran crews, which Grizmund personally commands. To represent these elite crews, any other tank in a force led by Grizmund may take as many Ace Crew skills as they like, they are not restricted to one per vehicle. They may not take the same skill more than once per vehicle.

LIGHTNING145 PTS

	BS	Armour		
		Front	Side	Rear
Lightning	3	10	10	10

Unit Type:
 • Vehicle (Flyer)

Weapons and equipment:
 • Long-barrelled autocannon with an AA mount
 • Twin-linked lascannons

Options:

- The Lightning may carry either
 - 4 Hellstrike missiles+40 pts
 - 4 Bombs+40 pts
- The Lightning may replace its long-barrelled autocannon with:
 - 2 Hellstrike missilesfree
- The Lightning may take any of the following:
 - Flare/chaff launcher+10 pts
 - Armoured cockpit+20 pts
 - Infra-red targeting+5 pts
 - Illum flares+5 pts
 - Distinctive paint scheme/decals+10 pts

THUNDERBOLT180 PTS

	BS	Armour		
		Front	Side	Rear
Thunderbolt	3	10	10	10

Unit Type:
 • Vehicle (Flyer)

Weapons and equipment:
 • Two twin-linked autocannons
 • Twin-linked lascannons

Options:

- The Thunderbolt may carry either:
 - 4 Hellstrike missiles+40 pts
 - 4 Bombs+40 pts
- The Thunderbolt may take any of the following:
 - Flare/chaff launcher+10 pts
 - Armoured cockpit+20 pts
 - Infra-red targeting+5 pts
 - Illum flares+5 pts
 - Distinctive paint scheme/decals+10 pts

MARAUDER400 PTS

	BS	Armour		
		Front	Side	Rear
Marauder	3	10	10	10

Unit Type:
 • Superheavy Flyer

Weapons and equipment:
 • One twin-linked lascannon and two twin-linked heavy bolters.
 • The Marauder also carries twelve bombs in its bomb bay.

Options:

- The Marauder may replace its bombs with:
 - 2 Hellstorm bombsfree
- The Marauder may take any of the following:
 - Flare/chaff launcher+10 pts
 - Armoured cockpit+20 pts
 - Infra-red targeting+5 pts
 - Illum flares+5 pts
 - Distinctive paint scheme/decals+10 pts

Structure Points:
 • 3

Weapon	Range	Str.	AP	Type
Bomb	Bomb	6	4	Apocalyptic Barrage(1)* One-shot
Hellstorm	Hellstorm	7	3	Inferno** One-shot

**You can elect to have the Marauder drop as many bombs as you wish in a single bombing run – for each bomb dropped, roll once on the Apocalyptic Barrage template. But remember, each bomb can only be dropped once – when they're gone, they're gone!*

***Only one Hellstorm bomb may be dropped per bombing run.*

MARAUDER DESTROYER425 PTS

	BS	Armour		
		Front	Side	Rear
Marauder Destroyer	3	10	10	10

Unit Type:

- Super Heavy Flyer

Structure Points:

- 3

Weapons and equipment:

- Three twin-linked autocannons
- One twin-linked heavy bolter
- One twin-linked assault cannon
- The Marauder Destroyer carries 6 bombs in its bomb bay

Options:

- The Marauder Destroyer may carry either:
 - 8 Hellstrike missiles+80 pts
- The Marauder Destroyer may take any of the following:
 - Flare/chaff launcher+10 pts
 - Armoured cockpit+20 pts
 - Infra-red targeting+5 pts
 - Illum flares+5 pts
 - Distinctive paint scheme/decals+10 pts

Weapon	Range	Str.	AP	Type
Bomb	Bomb	6	4	Apocalyptic Barrage(1)* One-shot

**You can elect to have the Marauder drop as many bombs as you wish in a single bombing run – for each bomb dropped, roll once on the Apocalyptic Barrage template. But remember, each bomb can only be dropped once – when they're gone, they're gone!*

VALKYRIE AIRBORNE ASSAULT CARRIER100 PTS

	BS	Armour		
		Front	Side	Rear
Valkyrie	3	12	12	10

Unit Type:

- Vehicle (fast, skimmer)
- Flyer*

Transport Capacity:

- 12 models

Special Rules:

- Deep Strike
- Scout
- Grav Chute Insertion

Weapons and equipment:

- Multi-laser
- 2 Hellstrike missiles
- Searchlight
- Extra Armour

Options:

- Any Valkyrie may replace its multi-laser with:
 - Lascannon15 pts
- Any Valkyrie may exchange both its Hellstrike missiles for:
 - Two multiple rocket pods30 pts
- Any Valkyrie may take a pair of sponsons armed with:
 - Heavy bolters10 pts

Grav Chute Insertion

If the Valkyrie has moved flat out, passengers may still disembark, but they must do so as follows. Nominate any point which the Valkyrie or Vendetta moved over and deploy the squad as if it were deep striking onto that point. If the unit scatters, every model must immediately take a dangerous terrain test. If any of the models cannot be deployed, the unit is destroyed as described in the 1-2 result on the Deep Strike Mishap table.

**In games of Apocalypse the Valkyrie is treated as a Flyer with hover mode.*

VULTURE GUNSHIP105 PTS

	BS	Armour		
		Front	Side	Rear
Vulture	3	12	12	10

Unit Type:

- Vehicle (fast, skimmer)
- Flyer*

Special Rules:

- Deep Strike

Weapons and equipment:

- Heavy Bolter
- Twin-linked multi-laser
- Two Hellstrike missiles
- Searchlight
- Extra Armour

Options:

- A Vulture may replace its multi-lasers with:
 - Twin-linked autocannonsfree
 - Twin-linked missile launchers+10 pts
 - Twin-linked lascannons+15 pts
 - Two multiple rocket pods+20 pts
- A Vulture may replace its 2 Hellstrike missiles with:
 - 6 Bombs+40 pts
 - 6 Hunter-killer missiles+40 pts
 - Two multiple rocket pods+30 pts
- A Vulture may replace both its multi-lasers and Hellstrike missiles with:
 - One Twin-linked Punisher Gatling cannon+50 pts
- The Vulture may take any of the following:
 - Flare/chaff launcher+10 pts
 - Armoured cockpit+20 pts
 - Infra-red targeting+5 pts
 - Illum flares+5 pts
 - Distinctive paint scheme/decals+10 pts

**In games of Apocalypse the Vulture is treated as a Flyer with Hover mode.*

ARMoured BATTLEGROUP

ARMY LIST

“What I cannot crush with words I will crush with the tanks of the Imperial Guard.”

Solar Macharius

THE ARMoured REGIMENT

The Imperial Guard is the largest fighting force in the galaxy, and the largest military organisation in the long history of Mankind. It is huge, billions upon billions of men at arms and millions of tanks and artillery guns stand ready to fight for the Emperor. It is the Imperial Guard that must bear the brunt of the Imperium’s wars. Wherever there is conflict, there is the Imperial Guard.

The manpower for such a vast fighting force is drawn from across the Imperium. They come from primitive feral worlds and hive worlds, from death worlds and savage penal colonies. All must provide recruits for the Imperial Guard. Each planet owes tithes to the Imperium and part of these tithes are taken as manpower. These conscripts form new regiments or are shipped as replacements to regiments already in battle.

Many units are formed as infantry regiments, with tens of thousands of men. But others are trained and equipped as armoured regiments. The tanks and carriers of the armoured regiments form the cutting edge of the Imperial Guard’s fighting forces. It is their task to take battle deep into the heart of the enemy, striking fast and hard with overwhelming firepower to smash enemy defences.

WHY COLLECT AN ARMoured BATTLE GROUP?

The one overwhelming reason to collect an Armoured Battlegroup army is tanks! If you enjoy modelling and painting tanks then why play anything else? In standard Imperial Guard armies the heart of the force is the infantry, here it is the tanks and other armoured fighting vehicles. Whilst infantry still play their part, it is only as support to the heavy metal!

Modelling tanks is a real joy, and a player can lavish as much time on a tank as on a special character for other armies. Adding upgrades, crew, stowage, battle damage, rust and mud all help to bring a tank model to life. More experienced or ambitious players can move on to converting their vehicles, changing weapons or going so far as to create their own vehicles, from basic turret swaps or complete vehicles scratch built from plasticard. The background given earlier in this book provides the reasoning behind this diversity.

The standard equipment of an Armoured Battlegroup will be Leman Russ tanks, Chimera carriers and Basilisks, but it is unlikely that these three basic ‘troop types’ will sustain an avid collector for very long. Most players enjoy diversity, and like to have lots of troops to choose from. Thanks to the Imperial Armour model range, we have been able to produce a wide diversity of vehicles and weapons as models, giving armoured unit players as much choice as the player of any other army, be it Eldar, Chaos, Space Marines, etc.

One common criticism of tank heavy forces is they lack character (and characters!) There is no reason why an Armoured Battlegroup should not be strongly themed like any other army. Players should spend some time to name their force, even if it is something as simple as ‘The Armageddon 9th’. From the name you can then devise a colour scheme, it might be best to think about what terrain you are likely to be playing on most, or where the regiment is from. If you have a green board with woods and

hills, then a camouflage scheme that reflects this will help add character to the army. If you are ambitious then plan your army and terrain together, if you what to play on city fight terrain, then paint your vehicles in urban camouflage schemes. We have provided many examples in this book for you to copy. Next there is a numbering scheme to think about, again we have provided examples but feel free to make up your own. This has a practical value in helping you identify your vehicles from one another on the tabletop. You can also name individual vehicles. You also need army badges, campaign markings, honour badges and kill marking, as well as names for your ace tank crew commanders. Suddenly, an Armoured Battlegroup is packed with characterful details, which help bring the models to life on the tabletop.

IMPERIAL GUARD ARMoured BATTLEGROUP LIST

On the following pages you will find an army list that enables you to field an Imperial Guard Armoured Battlegroup army. This list includes all the models currently available from Forge World. The army list allows you to fight battles using the scenarios in the Warhammer 40,000 rulebook but also provides enough information to field Armoured Battlegroups in scenarios of your own devising or as part of a campaign.

The heart of this list is the ten or so tanks of a Tank Company, with Armoured Fist squads in support and with attached elements of specialist siege tanks or artillery. Other support comes from the regimental artillery firing from off-table and the Imperial Navy flying in close support.

This army list is provided for players who wish to use their Imperial Armour models en masse in games. If you only wish to use one or two models then I’d recommend sticking with the Imperial Guard Codex army list. The rules for each vehicle detail what choice each Imperial Armour vehicle is for a ‘standard’ Imperial Guard army.

USING FORCE ORGANISATION CHARTS

The army lists are used in conjunction with the Force Organisation chart from a scenario. Each chart is spit into five categories that correspond to the sections in the army list, and each category has one or more boxes. Each light tone box indicates that you may make one choice from that section of the army list, while a dark tone box means you must make a choice from that section.

Note that unless a model or vehicle forms part of a squad or squadron it counts as single choice from those available to the army.

Standard Mission

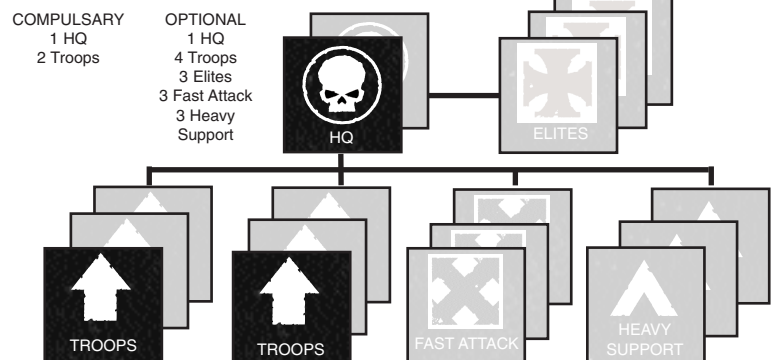

USING THE ARMY LISTS

To make a choice, look at the relevant section of the army list and decide which units you want to have in your army and which upgrades you want to give it (if any). Remember that you cannot field models equipped with weapons and wargear not shown on the model. This includes vehicle upgrades. Once this is done, subtract the points value of the unit from your total points and then go back and make another choice. Continue doing this until you have spent all your points.

ARMY LIST ENTRIES

Unit Name: The type of unit, including its points cost.

Profile: These are the characteristics of the unit type.

Unit Type: The vehicle type, such as tank, skimmer, which often has other rules relating to it. For details of these rules see the Warhammer 40,000 rulebook.

Wargear: The unit's standard weapons and equipment

Special Rules: Any special rules that apply to the unit.

Options: This lists different weapons and equipment options for the unit and the additional points cost that must be paid to take them. Details of upgrades can be found in the Armoury and Wargear section.

ARMOURED BATTLEGROUP SPECIAL RULES**ACE CREW SKILLS**

Many Imperial Guard armoured regiments have fought in the Imperium's wars for decades and gained much experience.

Any vehicle can be upgraded to an Ace Crew. Veterans of many campaigns, these are the best crews, well disciplined, experienced and well led. Any vehicle in an Armoured Battle Group can take a single Ace Crew skill. No vehicle may take more than one Ace Crew skill.

These skills can only be taken for standard vehicles. They cannot be taken by Weapons Platforms, Cyclops, Super-heavy vehicles or for any Imperial Navy aircraft.

Skilled Driver +5 pts

The driver can keep the tank moving, even in difficult terrain, finding the best routes of attack, picking the easiest routes across the ground. Using this skill you can re-roll the dice for crossing difficult ground. You must abide by the re-roll result even if it is worse.

Night Fighters +5 pts

The crew are experienced in fighting battles at night. They may re-roll the dice when rolling to determine how far they can see using Night Fight special rules. You must abide by the re-roll result even if it is worse.

Ace Gunner +10 pts

The gunner has an eye for finding weak spots on enemy vehicles. After rolling to hit, the gunner may add +1 to the Armour Penetration roll.

Disciplined Crew +10 pts

The crew have great discipline and mental strength. Ignore the effects of the first Crew Stunned result they suffer in the game.

Gung-ho! Crew +5 pts

The tank crew are happiest storming through the heart of the battle, where they can do the most damage. They are unperturbed by the presence of enemy infantry – for them it is just a target rich environment, they just keep on charging! An enemy infantry unit forced to take a Tank Shock test by this vehicle does so at -1 to their Leadership.

Battle Hardened Crew +10 pts

This crew is tough as old boots and have seen it all before. Nothing phases them, even in the heat of battle they grit their teeth and keep fighting. If the vehicle takes a Crew Shaken result on the Damage table, then roll a D6. On a 4+ ignore the result, the Battle Hardened Crew are unshaken by the enemy fire and fight on regardless.

Veteran Commander +10 pts

The commander is a veteran of many campaigns and knows how to keep his men fighting at their peak. The veteran commander gives the tank a single re-roll for the battle. This re-roll can be used on any one D6 roll which relates to the tank's action, this could be crossing difficult terrain, rolling to hit with a weapon, rolling to wound or for armour penetration. Note it is only a single dice, so the re-roll would allow one miss with the heavy bolter to be re-rolled, not all misses. It cannot be used on the Scatter dice, but can be used on a dice roll for the distance scattered. It cannot be used on rolls made by the enemy, such as Morale tests against Tank Shock, or armour saves.

Slick Loader +20 pts

The vehicle's loader quickly gets the main gun ready to fire after each shot. If the vehicle remains stationary, it may fire its main weapon twice in one turn. The second shot must be at the same target as the first. The vehicle cannot move at all and cannot fire any other weapons in the turn this skill is used. The weapon fired must be an ordnance weapon, you cannot use this skill on a heavy weapon.

19th MORDIAN ARMoured REGIMENT ORDER OF BATTLE: VAUST CAMPAIGN

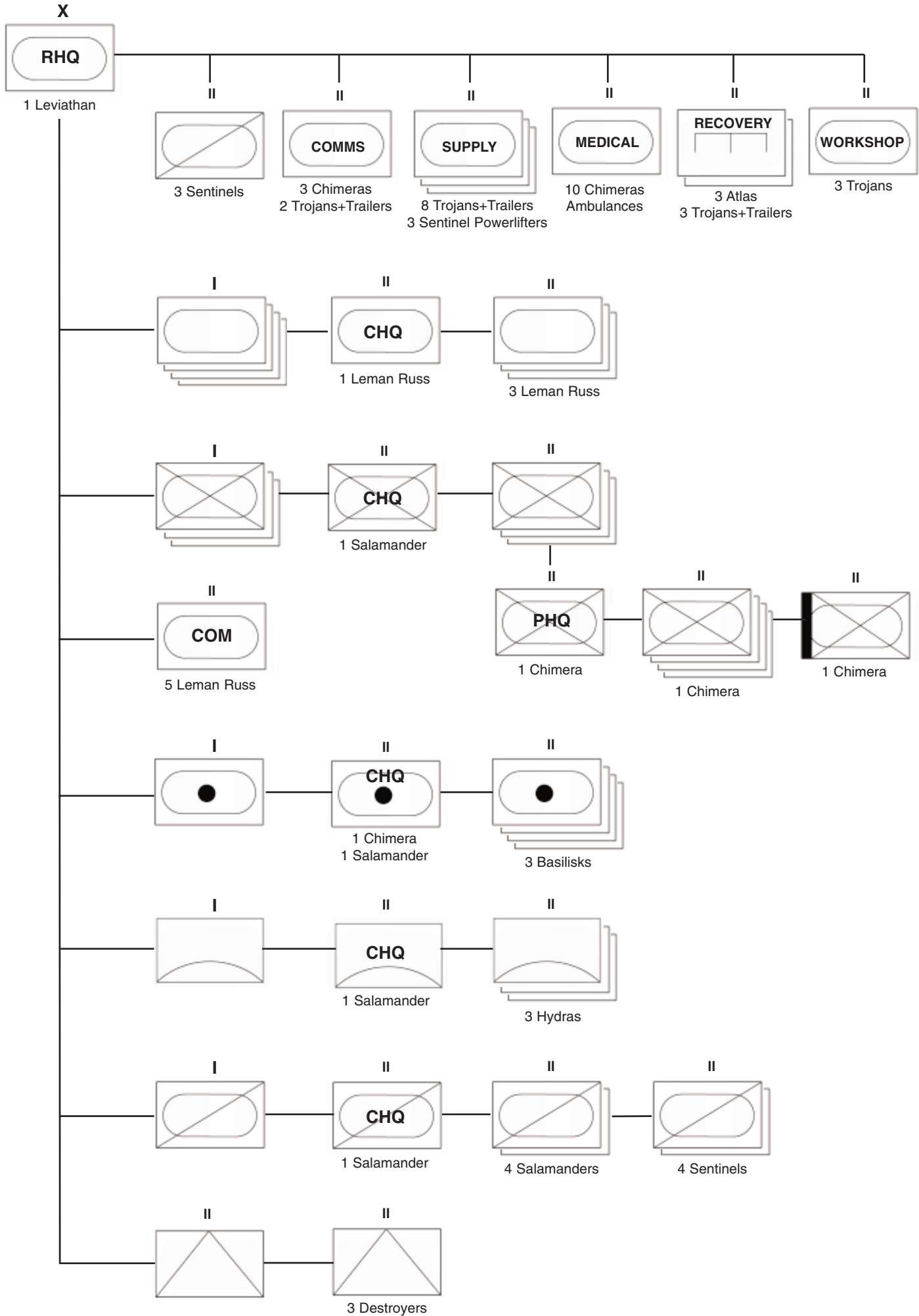

TEMPORARILY ATTACHED UNITS

These units were attached for the duration of the Taros campaign before being reassigned at the campaign's conclusion. The inclusion of these units, with extra men and vehicles required, increased support resources, especially Medical, Recovery and Workshop units, and Departamento Munitorum supply columns.

ALTERNATIVE VEHICLES

For clarity and simplicity only the main vehicle type is listed for each unit. The exact vehicles present may vary by type.
 For Leman Russ also read: Exterminator, Conqueror, Vanquisher, Executioner.
 For Demolisher also read: Thunderer or Hellhound.
 For CHQ Chimera's also read: Salamander Command Vehicle.
 For Basilisk also read: Griffon, Medusa, Bombard, Earthshaker Platform and Trojan, Medusa Platform and Trojan.
 For Hydra also read: Hydra Platform and tow.

TO & E

Personel		Weapons	
1	Colonel	695	Las pistols
17	Captains	166	Close combat weapons (various types)
48	Lieutenants	865	Lasguns
5	Commissars	19	Heavy Bolters
210	Sergeants	19	Mortars
1064	other ranks	19	Lascannons
1345	Total	11	Autocannons
		11	Missile Launchers
		20	Melta guns
		20	Plasma guns
		20	Grenade Launchers
		20	Flamers
		9	Heavy Flamers
		1894	Total

Vehicles	
45	Leman Russ
10	Demolishers
12	Basilisks
9	Hydras
11	Sentinels
9	Sentinel Powerlifters
13	Salamanders
3	Destroyers
3	Medusa
9	Cyclops
3	Bridges
94	Chimeras
35	Trojans
6	Atlas
3	Baneblades
1	Shadowsword
266	Total

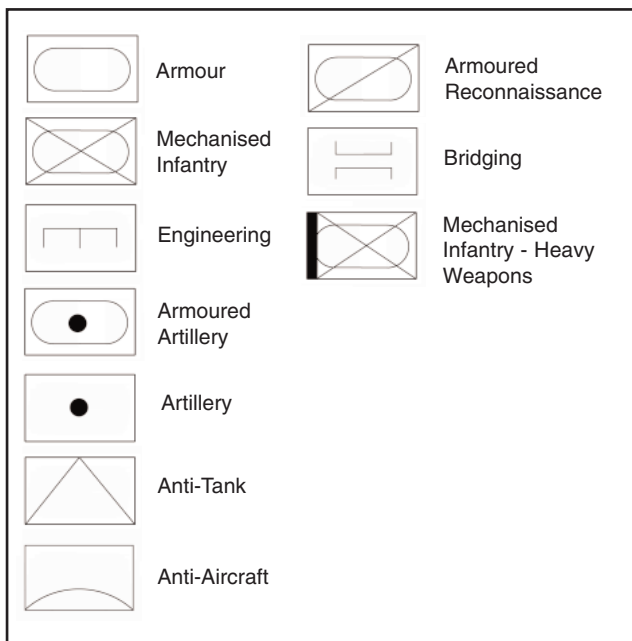
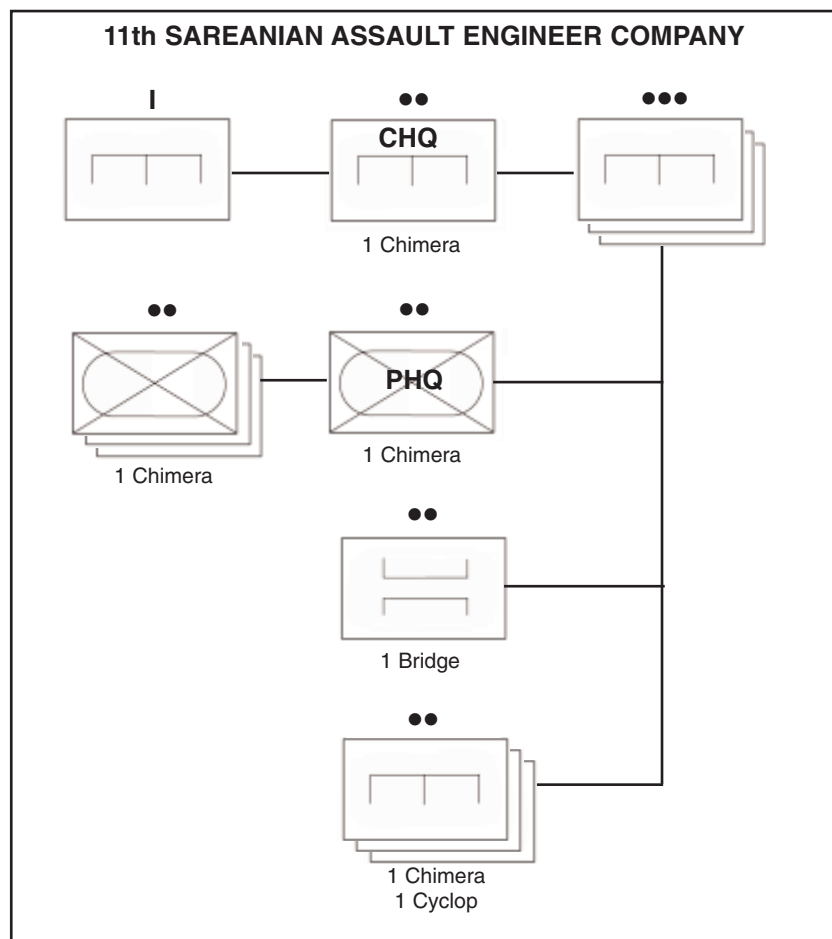
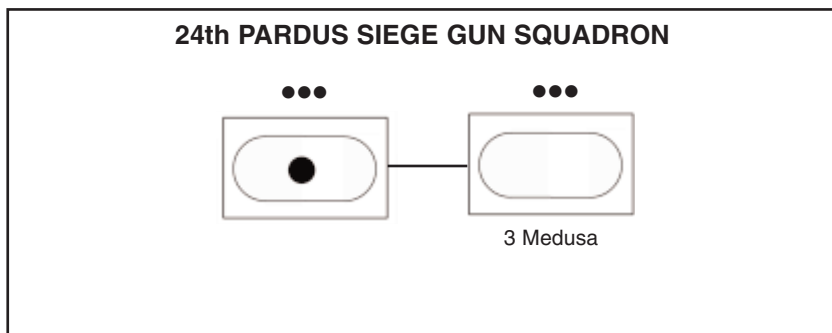
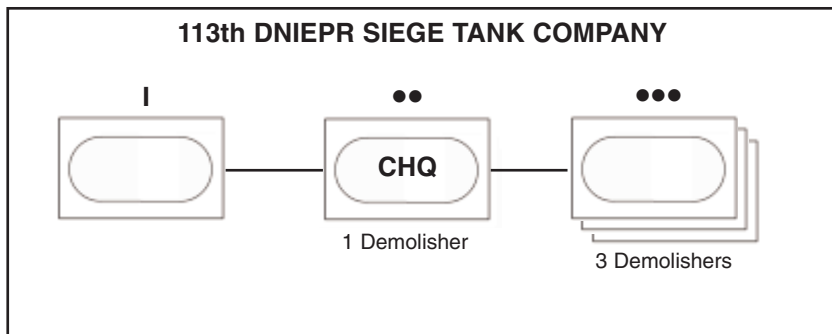
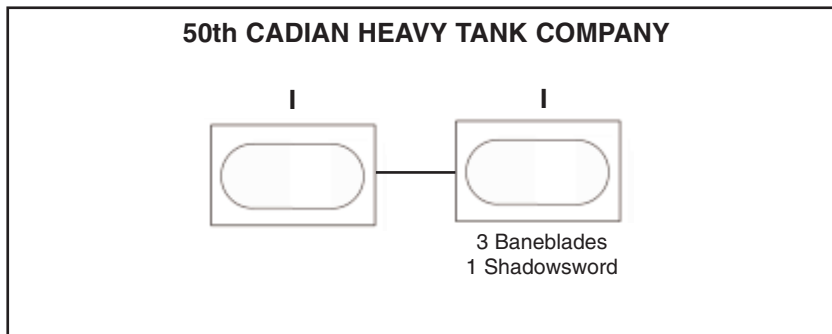

IMPERIAL NAVY AIRCRAFT UPGRADES

Flare or Chaff Launcher

Flares and chaff are launched to fool enemy fire aimed at the aircraft. If it takes a Vehicle Immobilised damage result on the damage tables then re-roll the result. The second result must stand even if it is another immobilised result. The flare or chaff launcher only works once. Once it has been used it cannot be used again.

Armoured Cockpit

Reinforced armour around the cockpit helps to keep the pilot and crew safe from incoming fire. If the aircraft takes a Crew Shaken, Crew Stunned or Pilot Shaken result on the Damage table, then on a dice roll of 4+ the effect is ignored.

Infrared Targeting

The aircraft has been modified to fight at night. When used in a game with Night Fighting rules, the aircraft can re-roll the dice for the distance it can engage enemies at. You must abide by the second result even if it is worse than the first.

Illum Flare

The aircraft carries a bright flare, which is dropped to illuminate the battlefield at night. The Illum flare can be used in missions where the rules for night fighting are used. They allow one enemy unit spotted by the aircraft to be fired at in the next turn by any other ground forces that are in range and have a line of sight.

Distinctive Paint Scheme or Decals

The crew have painted the aircraft in such a way as to make it stand out. Commonly, the nose of the plane is painted as the face of a monster, or the wings are given bright lightning flashes or similar decoration. This allows troops on the ground to recognise it, giving them the morale boost of knowing the Imperial Navy is at hand.

In the player's own turn, the first unit to fail a Morale test may re-roll the test. The unit must abide by the second result. To take a distinctive paint scheme upgrade it must be shown on the model.

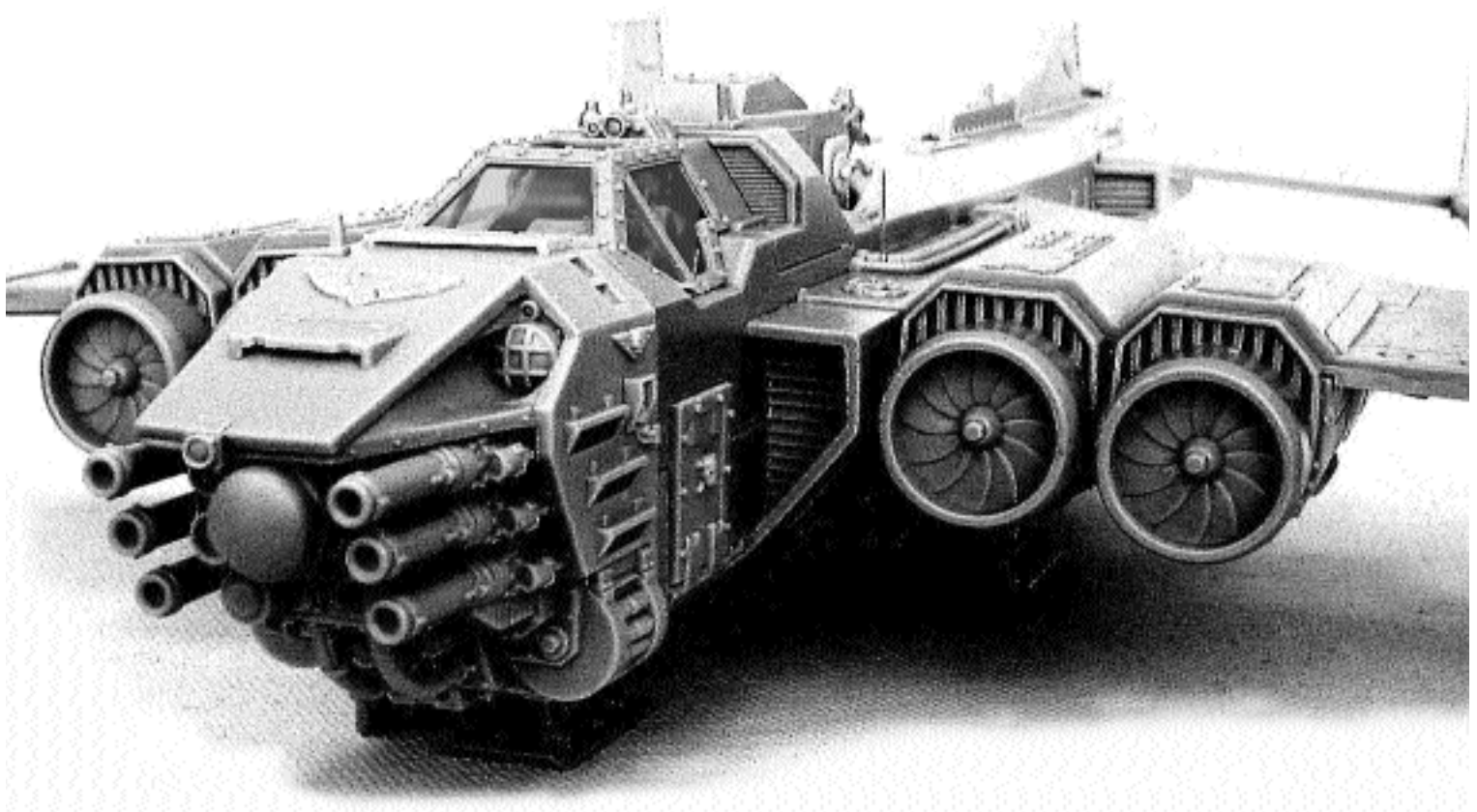

HEADQUARTERS

COMPANY COMMAND TANK 160 pts

	Armour			
	BS	Front	Side	Rear
Leman Russ	4	14	13	10

Unit Composition:

- 1 Leman Russ

Unit Type:

- Vehicle (Tank)

Wargear (ALL):

- Heavy Bolter
- Searchlight
- Smoke Launchers

Special Rules:

- Lumbering Behemoth (except Conqueror)
- Command Tank

Wargear:

- Leman Russ: Battle cannon
- Leman Russ Exterminator: Exterminator autocannons
- Leman Russ Conqueror: Conqueror cannon and co-axial stormbolter
- Leman Russ Annihilator: Twin-linked lascannons
- Leman Russ Vanquisher: Vanquisher battle cannon
- Leman Russ Eradicator: Eradicator nova cannon

Command Tank:

Whilst the Company Command tank is still mobile, any tank within 6" of it (including the command tank itself), may ignore 'crew shaken' results. As a Command tank it may also spot for an artillery strike.

Options:

- The model may upgrade to one of the following:
 - Exterminatorfree
 - Conquerorfree
 - Annihilatorfree
 - Vanquisher+ 5 pts
 - Eradicator+10 pts
- The model may exchange its heavy bolter for:
 - Heavy flamerfree
 - Lascannon+15 pts per model
- The model may take a pair of sponsons armed with:
 - Heavy bolters+20 pts
 - Heavy flamers+20 pts
 - Multi-meltas+30 pts
 - Plasma cannons+40 pt
- The model may take any of the following:
 - Pintle-mounted heavy stubber or storm bolter+10 pts
 - Hunter-killer missile+10 pts
 - Dozerblade+10 pts
 - Extra armour+15 pts
 - Camo-netting+20 pts
- A Vanquisher may have:
 - co-axial storm bolter or heavy stubber+10 pts

ARMoured FIST COMPANY COMMANDER55 pts

	Armour			
	BS	Front	Side	Rear
Salamander	3	12	10	10

Unit Composition:

- 1 Salamander Command vehicle

Unit Type:

- Vehicle (tank, open-topped)

Wargear:

- Heavy flamer
- Heavy bolter
- Searchlight
- Smoke launchers
- Surveyor

Special Rules:

- Mobile Command Vehicle

Options:

- Replace heavy flamer with:
 - Heavy Bolterfree
- Take any of the following:
 - Pintle-mounted heavy stubber or storm bolter +10 pts
 - Hunter-killer missile+10 pts
 - Dozerblade+10 pts
 - Extra armour+15 pts
 - Camo-netting+20 pts

Mobile Command Vehicle

The Salamander Command may issue orders just like a Company Commander. It may issues 2 orders to units (not vehicles within 12". It may issue the following orders: Bring it Down!, Fire on My target!, Get back in the Fight!, First rank, FIRE! second rank FIRE!, Incoming!, and Move! Move! Move! orders. It always counts as having a vox.

As a command vehicle it may also spot for an artillery strike.

Surveyor

Each Salamander command vehicle is fitted with a driver's surveyor. No enemy infiltrators may set up within 4D6" of the Salamander command. Roll the dice before the enemy set up any of their infiltrators.

ATLAS RECOVERY TANK85 pts

Atlas recovery tanks do not use up any Force Organisation chart selections, but otherwise are treated as separate HQ units

	Armour			
	BS	Front	Side	Rear
Atlas	3	14	13	10

Unit Composition:

- 1 Atlas Recovery Tank

Unit Type:

- Vehicle (tank)

Wargear:

- Heavy Bolter
- Searchlight
- Smoke launchers

Special Rules:

- Recovery tank
- Repair

Options:

- An Atlas may take any of the following:
 - Pintle-mounted heavy stubber or storm bolter+10 pts
 - Hunter-killer missile+10 pts
 - Dozerblade+10 pts
 - Extra armour+15 pts
 - Camo-netting+20 pts

<p>Recovery Tank The Atlas can drag any destroyed or immobilised vehicle (friend or foe) that it starts the turn in contact with. Both vehicles may move up to D6" and must remain in contact with each other. Neither vehicle may shoot in the same turn that they are towing or being towed in. The Atlas can be used to move a completely destroyed vehicle out of the way if it is blocking movement, or move a vehicle that is immobilised in difficult terrain out of the terrain so it can move again.</p>	<p>Repair If the Atlas starts the turn in contact with a damaged vehicle, in the Shooting phase it can attempted to repair it instead of shooting or towing. Roll a D6. If the result is a 5+ then a weapon destroyed or Immobilised result (owning player's choice) is repaired. If a weapon destroyed result is repaired, that weapon can then be fired in the following Shooting phase.</p>
--	---

COMMISSAR TANK160 pts

	Armour			
	BS	Front	Side	Rear
Leman Russ	4	14	13	10

Unit Composition:

- 1 Leman Russ

Unit Type:

- Vehicle (Tank)

Wargear (ALL):

- Heavy Bolter
- Searchlight
- Smoke Launchers

Wargear:

- Leman Russ: Battle cannon
- Leman Russ Exterminator: Exterminator autocannons
- Leman Russ Conqueror: Conqueror cannon and co-axial stormbolter
- Leman Russ Annihilator: Twin-linked lascannons
- Leman Russ Vanquisher: Vanquisher battle cannon

Special Rules:

- Lumbering Behemoth (except Conqueror)

Options:

- The model may upgrade to one of the following:
 - Exterminatorfree
 - Conquerorfree
 - Annihilatorfree
 - Vanquisher+ 5 pts
 - Eradicator+10 pts
- The model may exchange its heavy bolter for:
 - Heavy flamerfree
 - Lascannon+15 pts per model
- The model may take a pair of sponsons armed with:
 - Heavy bolters+20 pts
 - Heavy flamers+20 pts
 - Multi-meltas+30 pts
 - Plasma cannons+40 pt
- The model may take any of the following:
 - Pintle-mounted heavy stubber or storm bolter+10 pts
 - Hunter-killer missile+10 pts
 - Dozerblade+10 pts
 - Extra armour+15 pts
 - Camo-netting+20 pts
- A Vanquisher may have:
 - co-axial storm bolter or heavy stubber+10 pts

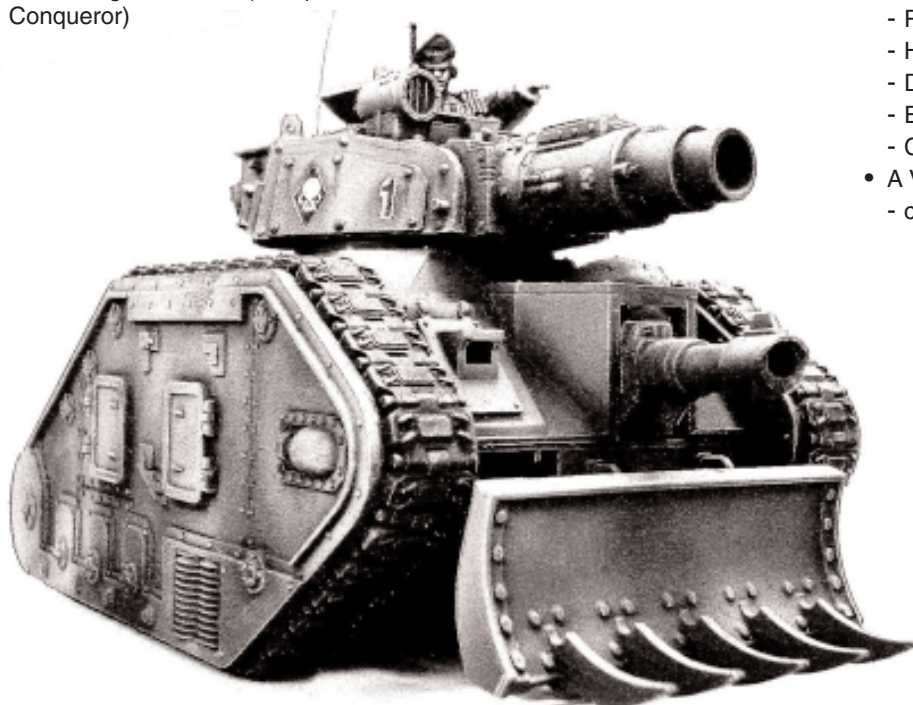

Commissariat Crew
Any Imperial Guard unit within 6" of a Commissar's tank count their leadership value as 10.

ELITES

SQUADRON COMMAND TANK150 pts

	Armour			
	BS	Front	Side	Rear
Leman Russ	3	14	13	10
Leman Russ*	3	14	13	11

*Demolisher, Punisher and Executioner only

Unit Composition:

- 1 Leman Russ

Unit Type:

- Vehicle (Tank)

Wargear (ALL):

- Heavy Bolter
- Searchlight
- Smoke Launchers

Special Rules:

- Lumbering Behemoth (except Conqueror)

Wargear:

- Leman Russ: Battle cannon
- Leman Russ Exterminator: Exterminator autocannons
- Leman Russ Conqueror: Conqueror cannon and co-axial stormbolter
- Leman Russ Annihilator: Twin-linked lascannons
- Leman Russ Vanquisher: Vanquisher battle cannon
- Leman Russ Eradicator: Eradicator nova cannon
- Leman Russ Demolisher*: Demolisher cannon
- Leman Russ Punisher*: Punisher Gatling cannon
- Leman Russ Executioner*: Executioner plasma cannon

Options:

- The model may upgrade to one of the following:
 - Exterminatorfree
 - Conquerorfree
 - Annihilatorfree
 - Vanquisher+ 5 pts
 - Eradicator+10 pts
 - Demolisher+15 pts
 - Punisher+30 pts
 - Executioner+40 pts
- The model may exchange its heavy bolter for:
 - Heavy flamerfree
 - Lascannon+15 pts per model
- The model may take a pair of sponsons armed with:
 - Heavy bolters+20 pts
 - Heavy flamers+20 pts
 - Multi-meltas+30 pts
 - Plasma cannons+40 pt
- The model may take any of the following:
 - Pintle-mounted heavy stubber or storm bolter+10 pts
 - Hunter-killer missile+10 pts
 - Dozerblade+10 pts
 - Extra armour+15 pts
 - Camo-netting+20 pts
- A Vanquisher may have:
 - co-axial storm bolter or heavy stubber+10 pts

ARMoured FIST PLATOON COMMAND SQUAD80 pts

	WS	BS	S	T	W	I	A	Ld	Sv
Platoon Cmdr	4	4	3	3	1	3	2	8	5+
Guardsmen	3	3	3	3	1	3	1	7	5+
Hvy Wpns Team	3	3	3	3	2	3	2	7	5+

Unit Composition:

- 1 Platoon Commander
- 4 Guardsman in a Chimera

Unit Type:

- Infantry

Wargear:

- Flak armour
- Lasgun
- Close combat weapon
- Frag grenades

Special Rules:

- Junior Officer (Platoon Commander only)

Dedicated Transport:

- The squad always has a Chimera as a dedicated transport vehicle.

Options:

- The Platoon Commander may exchange his laspistol for:
 - Bolt pistol+2 pts
- The Platoon Commander may take melta bombs+5 pts
- The Platoon Commander may exchange his laspistol and close combat weapon for:
 - Bolt gun+2 pts
 - Power sword+10 pts
 - Plasma pistol+10 pts
 - Power fist+15 pts
- Any guardsman may replace his lasgun with a:
 - Laspistolfree
- One Guardsman may be upgraded to carry:
 - Voxcaster+5 pts
- One Guardsman may be upgraded to carry:
 - Platoon Standard+15 pts
- One guardsman may replace his lasgun with a:
 - Heavy flamer+20 pts
- Replace two other guardsmen with a Heavy Weapons team armed with one of the following:
 - Mortar+5 pts
 - Autocannon or Heavy bolter+10 pts
 - Missile launcher+15 pts
 - Lascannon+20 pts
- Any guardsmen not upgraded to one of the following may replace his lasgun with:
 - Flamer, grenade launcher or sniper rifle+5 pts
 - Melta gun+10 pts
 - Plasma gun+15 pts
- The entire squad may have krak grenades . . .+5 pts

STORM TROOPER SQUAD85 pts

	WS	BS	S	T	W	I	A	Ld	Sv
Storm Trooper	3	4	3	3	1	3	1	7	4+
Storm Trooper Sgt	3	4	3	3	1	3	2	8	4+

Unit Composition:

- 1 Storm Trooper Sergeant
- 4 Storm Troopers

Unit Type:

- Infantry

Wargear:

- Carapace armour
- Hot-shot lasgun
- Hot-shot laspistol
- Close-combat weapon
- Frag grenades
- Krak grenades

Special Rules:

- Special Operations

Transport:

- The squad may take a Chimera as a dedicated transport.

Options:

- May have up to five
 - additional Storm Troopers16 points per model
- The Storm Trooper Sergeant may exchange his hot-shot laspistol and/or hot-shot lasgun for:
 - Bolt pistol or boltgunfree
 - Power weapon10 pts
 - Plasma pistol10 pts
- Up to two Storm Troopers may replace their hot-shot lasgun with:
 - Flamer5 pts per model
 - Grenade launcher5 pts per model
 - Meltagun10 pts per model
 - Plasma gun15 pts per model

TECHPRIEST ENGINEER45 pts

An armoured battlegroup may include 0-2 Techpriest Engineers. Techpriest Engineers do not use up any Force Organisation chart selections, but are otherwise treated as separate Elite units.

	WS	BS	S	T	W	I	A	Ld	Sv
Techpriest E'seer	3	3	3	3	1	3	1	8	3+
Servitor	3	3	3	3	1	3	1	8	4+

Unit Composition:

- 1 Techpriest

Unit Type:

- Infantry

Wargear (Techpriest):

- Power armour
- Laspistol
- Power weapon
- Servo-arm
- Frag and krak grenades

Wargear (Servitor):

- Servo-arm
- Carapace armour

Special Rules:

- Blessings of the Ommissiah
- Mindlock

Options:

- May be accompanied by up to five Servitors
 -15 pts per model
- Up to two Servitors may replace their servo-arm with:
 - A heavy bolter20 pts
 - A multi-melta or plasma-cannon30 pts
- The Techpriest may take a Chimera as a dedicated transport vehicle55 pts
- The Techpriest may take melta bombs5 pts

DEDICATED TRANSPORTS

Many Imperial Guard units have the option of selecting a dedicated transport vehicle. These vehicles do not use up any force organisation chart selections, but otherwise function as separate units. See the Vehicles section of the Warhammer 40,000 rulebook for details of how transport vehicles operate.

CHIMERA ARMOURED TRANSPORT55 pts

	Armour			
	BS	Front	Side	Rear
Chimera	3	12	10	10

Unit Composition:

- 1 Chimera

Unit Type:

- Vehicle (tank)

Transport Capacity:

- 12 models

Wargear:

- Multi-laser
- Heavy bolter
- Searchlight
- Smoke Launchers

Special Rules:

- Amphibious
- Mobile Command Vehicle

Options:

- Replace multi-laser with:
 - Heavy flamer or heavy bolterfree
 - Autocannon5 pts
 - Twin-linked heavy bolters10 pts
- Replace heavy bolter with:
 - Heavy flamerfree
- Take any of the following:
 - Pintle-mounted storm bolter or heavy stubber .10 pts
 - Hunter-killer missile10 pts
 - Dozer blade10 pts
 - Extra armour15 pts
 - Camo netting20 pts

TROOPS

TANK SQUADRON150 pts per tank

	Armour			
	BS	Front	Side	Rear
Leman Russ	3	14	13	10
Leman Russ*	3	14	13	11

*Demolisher, Punisher and Executioner only

Unit Composition:

- 1-3 Leman Russ Tanks

Unit Type:

- Vehicle (Tank)

Wargear (ALL):

- Heavy Bolter
- Searchlight
- Smoke Launchers

Special Rules:

- Lumbering Behemoth (except Conqueror)

Wargear:

- Leman Russ: Battle cannon
- Leman Russ Exterminator: Exterminator autocannons
- Leman Russ Conqueror: Conqueror cannon and co-axial stormbolter
- Leman Russ Annihilator: Twin-linked lascannons
- Leman Russ Vanquisher: Vanquisher battle cannon
- Leman Russ Eradicator: Eradicator nova cannon
- Leman Russ Demolisher*: Demolisher cannon
- Leman Russ Punisher*: Punisher Gatling cannon
- Leman Russ Executioner*: Executioner plasma cannon

Options:

- Any model may upgrade to one of the following:
 - Exterminatorfree
 - Conquerorfree
 - Annihilatorfree
 - Vanquisher+ 5 pts per model
 - Eradicator+10 pts per model
 - Demolisher+15 pts per model
 - Punisher+30 pts per model
 - Executioner+40 pts per model
- Any model may exchange its heavy bolter for:
 - Heavy flamerfree
 - Lascannon+15 pts per model
- Any model may take a pair of sponsons armed with:
 - Heavy bolters+20 pts
 - Heavy flamers+20 pts
 - Multi-meltas+30 pts
 - Plasma cannons+40 pt
- Any model may take any of the following:
 - Pintle-mounted heavy stubber or storm bolter+10 pts
 - Hunter-killer missile+10 pts
 - Dozerblade+10 pts
 - Extra armour+15 pts
- The entire squadron may take:
 - Camo-netting+20 pts per model
- A Vanquisher may have:
 - co-axial storm bolter or heavy stubber+10 pts

ARMOURED FIST SQUAD105 pts

	WS	BS	S	T	W	I	A	Ld	Sv
Sergeant	3	3	3	3	1	3	1	8	5+
Guardsmen	3	3	3	3	1	3	1	7	5+
Hvy Wpns Team	3	3	3	3	2	3	2	7	5+

Unit Composition:

- 1 Sergeant
- 9 Guardsman in a Chimera

Unit Type:

- Infantry

Wargear:

- Flak armour
- Lasgun
- Close combat weapon
- Frag grenades

Special Rules:

- None

Dedicated Transport:

- The squad has a Chimera as a dedicated transport vehicle, and the points are included above. Any options or upgrades taken for the Chimera cost additional points.

Options:

- The Sergeant may take melta bombs+5 pts
- The Sergeant may exchange his lasgun or close combat weapon for:
 - Bolt pistol+2 pts
 - Power sword+10 pts
 - Plasma pistol+10 pts
- Any guardsman may replace his lasgun with a:
 - Laspistolfree
- One Guardsman may be upgraded to carry:
 - Voxcaster+5 pts
- Replace two Guardsmen with a Heavy Weapons team armed with one of the following:
 - Mortar+5 pts
 - Autocannon or Heavy bolter+10 pts
 - Missile launcher+15 pts
 - Lascannon+20 pts
- One guardsmen may replace his lasgun with:
 - Flamer, grenade launcher or sniper rifle+5 pts
 - Melta gun+10 pts
 - Plasma gun+15 pts
- The entire squad may have Krak grenades+10 pts

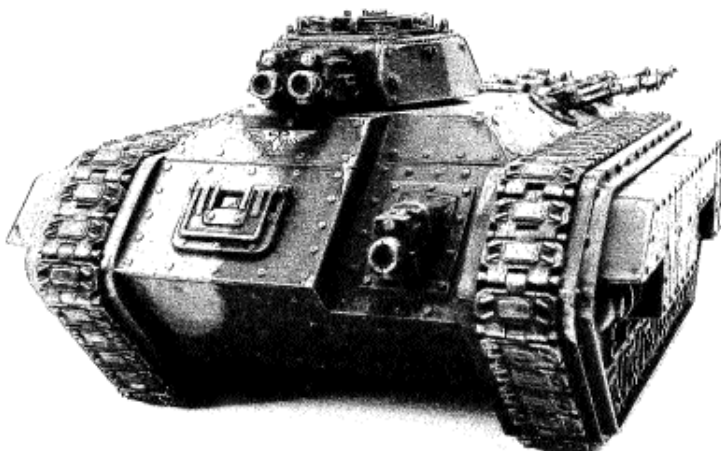

FAST ATTACK

SCOUT SENTINEL SQUADRON35 pts per model

	Armour							
	WS	BS	S	F	S	R	I	A
Scout Sentinel	3	3	5	10	10	10	3	1

Unit Composition:

- Squadron of 1-3 Scout Sentinels

Unit Type:

- Vehicle (walker, open-topped)

Wargear:

- Multi-laser

Special Rules:

- Scouts
- Move through Cover

Options:

- Any Sentinel may replace its multi-laser with one of the following:
 - Heavy flamer+5 pts per model
 - Autocannon+5 pts per model
 - Missile launcher+10 pts per model
 - Multiple Rocket pod+15 pts per model
 - Lascannon+15 pts per model
- Any model may take any of the following:
 - Searchlight+1 pts per model
 - Hunter-killer missile+10 pts per model
- The entire squadron may take:
 - Smoke launchers+5 pts per model
 - Camo-netting+10 pts per model

ARMoured SENTINEL SQUADRON55 pts per model

	Armour							
	WS	BS	S	F	S	R	I	A
Armoured Sentinel	3	3	5	12	10	10	3	1

Unit Composition:

- Squadron of 1-3 Armoured Sentinels

Unit Type:

- Vehicle (walker)

Wargear:

- Multi-laser
- Extra Armour

Options:

- Any Sentinel may replace its multi-laser with one of the following:
 - Heavy flamer+5 pts per model
 - Autocannon+5 pts per model
 - Missile launcher+10 pts per model
 - Multiple Rocket pod+15 pts per model
 - Lascannon+15 pts per model
 - Plasma cannon+20 pts per model
- Any model may take any of the following:
 - Searchlight+1 pts per model
 - Hunter-killer missile+10 pts per model
- The entire squadron may take:
 - Smoke launchers+5 pts per model
 - Camo-netting+10 pts per model

SALAMANDER RECON SQUADRON55 pts per model

	Armour			
	BS	Front	Side	Rear
Salamander	3	12	10	10

Unit Composition:

- Squadron of 1 to 3 Salamanders

Unit Type:

- Vehicle (tank, open-topped)

Wargear:

- Autocannon
- Heavy bolter
- Searchlight
- Smoke launchers

Special Rules:

- Overcharged Engines

Options:

- Take any of the following:
 - Pintle-mounted heavy stubber or storm bolter +10 pts
 - Hunter-killer missile+10 pts
 - Dozerblade+10 pts
 - Extra armour+15 pts
 - Camo-netting+20 pts

Overcharged Engines

The Salamander is fitted with a specially modified engine. These engines allow Salamanders to attempt to go faster but at the risk of stalling the engines. You may declare that an eligible vehicle is going to use its overcharged engines in any Movement phase just before you move it.

Roll a D6. On the roll of a 1 the engine stalls and the vehicle may not move at all this turn. On a 2-3 the boosters fail to kick in, the vehicle moves normally. On the roll of 4-6 the boosters work and vehicle is treated as a fast vehicle for the entire turn.

HELLHOUND SQUADRON

Composition: Vehicle squadron composed of 1-3 of the following tanks, in any combination:

HELLHOUND130 pts per model
 DEVIL DOG120 pts per model
 BANE WOLF130 pts per model

	Armour			
	BS	Front	Side	Rear
Hellhound	3	12	12	10
Devil Dog	3	12	12	10
Bane Wolf	3	12	12	10

Unit Type:

- Vehicle (tank, fast)

Wargear (All):

- Heavy bolter

Wargear

Hellhound:

- Inferno cannon

Devil Dog:

- Melta cannon

Bane Wolf:

- Chem cannon

Options:

- Any model may replace heavy bolter with:
 - Heavy flamerfree
 - Multi-melta15 pts per model
- Any model may take any of the following:
 - Searchlight1 pt per model
 - Pintle-mounted storm bolter or heavy stubber10 pts per model
 - Hunter-killer missile10 pts per model
 - Dozer blade10 pts per model
 - Extra armour15 pts per model
- The entire squadron may take:
 - Smoke launchers5 points per model
 - Camo netting20 points per model

VALKYRIE ASSAULT CARRIER SQUADRON100 pts per model

	Armour			
	BS	Front	Side	Rear
Valkyrie	3	12	12	10

Unit Composition:

- Vehicle squadron of 1-3 Valkyries

Unit Type:

- Vehicle (fast, skimmer)

Transport Capacity:

12 models

Wargear:

- Multi-laser
- 2 Hellstrike Missiles
- Searchlight
- Extra Armour

Special Rules:

- Deep Strike
- Scout
- Grav Chute Insertion

Options:

- Any Valkyrie may replace its multi-laser with:
 - Lascannon15 pts per model
- Any Valkyrie may exchange both of its hellstrike missiles for:
 - Two multiple rocket pods30 pts per model
- Any Valkyrie may take a pair of sponsons armed with:
 - Heavy bolters10 pts per model

VENDETTA GUNSHIP SQUADRON130 pts per model

	Armour			
	BS	Front	Side	Rear
Vendetta	3	12	12	10

Unit Composition:

- Vehicle squadron of 1-3 Vendettas

Unit Type:

- Vehicle (fast, skimmer)

Transport Capacity:

- 12 models

Wargear:

- 3 twin-linked lascannons
- Searchlight
- Extra Armour

Special Rules:

- Deep Strike
- Scout
- Grav Chute Insertion

Options:

- Any Vendetta may exchange two twin-linked lascannons for:
 - Two hellfury missilesfree
- Any Vendetta may take a pair of sponsons armed with:
 - Heavy bolters10 points per model

HEAVY SUPPORT

DESTROYER TANK HUNTER SQUADRON .160 pts per model

	Armour			
	BS	Front	Side	Rear
Destroyer	3	14	13	10

Unit Composition:

- 1-3 Destroyers

Unit Type:

- Vehicle (Tank)

Wargear:

- Laser Destroyer Cannon
- Searchlight
- Smoke Launchers

Options:

- Any Destroyer may take any of the following:
 - Pintle-mounted heavy stubber or storm bolter +10 pts
 - Hunter-killer missile+10 pts
 - Dozerblade+10 pts
 - Extra armour+15 pts
 - Camo-netting+20 pts

Laser Destroyer Cannon			
Range	Str	AP	Special
72"	10	2	Ordnance 1

THUNDERER SIEGE TANK SQUADRON ...140 pts per model

	Armour			
	BS	Front	Side	Rear
Thunderer	3	14	13	11

Unit Composition:

- 1-3 Thunderers

Unit Type:

- Vehicle (Tank)

Wargear:

- Demolisher cannon
- Searchlight
- Smoke Launchers

Options:

- Any Thunderer may take any of the following:
 - Pintle-mounted heavy stubber or storm bolter +10 pts
 - Hunter-killer missile+10 pts
 - Dozerblade+10 pts
 - Extra armour+15 pts
 - Camo-netting+20 pts

HYDRA FLAK TANK BATTERY75 pts per model

	Armour			
	BS	Front	Side	Rear
Hydra	3	12	10	10

Unit Composition:

- Vehicle squadron of 1-3 Hydra Flak tanks

Unit Type:

- Vehicle (tank)

Wargear:

- Two twin-linked Hydra autocannons
- Heavy bolter
- Searchlight
- Smoke launchers
- Auto-targeting System

Special Rules:

- AA mount

Options:

- Any model may replace its heavy bolter with:
 - Heavy flamerfree
- Any model may take any of the following:
 - Pintle-mounted storm bolter or heavy stubber10 pts per model
 - Hunter-killer missile10 pts per model
 - Dozer blade10 pts per model
 - Extra armour15 pts per model
- The entire squadron may take:
 - Camo netting20 pts per model



ORDNANCE BATTERY

Composition: Vehicle squadron composed of 1-3 of the following tanks, in any combination:

BASILISK125 pts
MEDUSA135 pts
COLOSSUS140 pts
GRIFFON75 pts

	BS	Armour		
		Front	Side	Rear
Basilisk	3	12	10	10
Medusa	3	12	10	10
Colossus	3	12	10	10
Griffin	3	12	10	10

Unit Type:

- Vehicle (tank, open-topped)

Wargear (All):

- Heavy bolter
- Searchlight
- Smoke launchers

Wargear

- Basilisk:
Earthshaker cannon
- Medusa:
Medusa siege cannon
- Colossus:
Colossus siege mortar
- Griffin:
Griffon heavy mortar

Special Rules:

- Accurate Bombardment (Griffon only)

Options:

- Any model may replace its heavy bolter with:
 - Heavy flamerfree
- Any model may take any of the following:
 - Enclosed crew compartment15 pts per model
 - Pintle-mounted storm bolter or heavy stubber10 pts per model
 - Hunter-killer missile10 pts per model
 - Dozer blade10 pts per model
 - Extra armour15 pts per model
- The entire squadron may take:
 - Camo netting30 pts per model
- Any Medusa may take bastion-breacher shells5 pts per model

ARTILLERY STRIKE

	Pts	Str	AP	Type
Bombard Strike	100	8	3	Ordnance, 7" blast
Manticore Strike	90	9	2	Ordnance, 5" blast
Basilisk Strike	70	9	3	Ordnance, 5" blast
Griffon Strike	50	6	4	Ordnance, 5" blast
Mortar Battery Strike	50	4	6	Heavy 3, small blast
Colossus Strike	60	6	3	Ordnance 1/ 5" blast*
Medusa Strike	60	9	3	Ordnance 1/ 5" blast

• Timing:

An artillery strike will always use the Reserves special rules even in missions where reserves are not allowed. Once the artillery strike is available, it lands in each Shooting phase of the Imperial Guard player's turn thereafter. The Imperial Guard player may opt not to roll for the availability of the artillery strike if he wishes, but once the roll has passed and the forward observer or officer has selected the target, the artillery strike will continue.

• Placement:

The blast marker for the artillery strike can be placed anywhere visible to the forward observer that is calling in the fire. This can be any model equipped with a vox-caster. The target can be an enemy model or just a point on the tabletop.

• (In)accuracy:

An artillery strike scatters just like an ordnance weapon, but if a miss is rolled, the distance scattered is double the score on 2D6. If a hit is rolled, the template deviates by the distance shown on the dice in the direction indicated by the arrow on the 'Hit' symbol.

• Pinning:

All artillery strikes cause Pinning tests as for the standard rules for the weapon type fired.

• Apocalypse:

In games of Apocalypse, only one artillery strike may be taken per 1000 points in the force.

*No cover saves may be taken against hits from a colossus

BOMBARD BATTERY145 pts per model

	Armour			
	BS	Front	Side	Rear
Bombard	3	12	10	10

Unit Composition:

- Vehicle squadron of 1 -3 Bombards

Unit Type:

- Vehicle (tank)

Wargear:

- Bombard Heavy Siege Mortar
- Searchlight
- Smoke launchers

Special rules:

- Slow
- Slow Rate of Fire

Slow
The Bombard can only move slowly. It is limited to a maximum move of 6" per turn. It cannot move and fire in the same turn, it must remain stationary to fire.

Slow Rate of Fire
The bombard takes along time to reload its huge shells. It may only fire every other turn, so after firing it must miss a turn whilst it reloads. It cannot move and reload at the same time.

BOMBARD HEAVY SIEGE MORTAR

Range	Str	AP	Type
36-240"	8	3	Ordnance 1, 7" Blast, Barrage

Options:

- Each Bombard may take:
 - Trojan and Trailer*free
- Any model may take any of the following:
 - Pintle mounted heavy stubber10 pts per model
 - Pintle mounted storm bolter10 pts per model
 - Hunter-killer missile10 pts per model
 - Dozerblade10 pts per model
 - Extra armour15 pts per model
- The entire squadron may take:
 - Enclosed crew compartment15 pts per model
 - Camo netting30 pts per model

* Any Imperial Guard force that contains a Bombard it may also include a Trojan and trailer for free. This is the Bombards ammunition vehicle. The Trojan counts as part of the Heavy Support choice of the Bombard. The Trojan is still worth Victory points/Kill points should it be destroyed. The rules for a Trojan and Trailer can be found in Imperial Armour Volume 1: Imperial Guard.

IMPERIAL NAVY AIR SUPPORT

- THUNDERBOLT**180 pts
LIGHTNING145 pts
VULTURE105 pts

	Armour			
	BS	Front	Side	Rear
Thunderbolt	3	10	10	10
Lightning	3	10	10	10
Vulture	3	12	12	10

Unit Composition:

- 1 Aircraft

Unit Type:

- Vehicle (Flyer)

Wargear:

- Thunderbolt:
 - Two twin-linked autocannons
 - Twin-linked lascannons
- Lightning:
 - Long-barrelled autocannon
 - Twin-linked lascannons
- Vulture:
 - Heavy Bolter
 - Twin-linked multi-lasers
 - Two hellstrike missiles

Special Rules:

- Hover Mode (Vulture only)

Options:

- The Thunderbolt may carry either:
 - 4 Hellstrike missiles+40 pts
 - 4 Bombs+40 pts
- The Lightning may carry either:
 - 4 Hellstrike missiles+40 pts
 - 4 Bombs+40 pts
- The Lightning may replace its long-barrelled autocannon with:
 - 2 Hellstrike missilesfree
- The Vulture may replace its twin-linked multi-lasers with:
 - Twin-linked autocannonsfree
 - Twin-linked lascannons+15 pts
 - Twin-linked missile launchers+10 pts
 - Two multiple rocket pods+20 pts
- The Vulture may replace its 2 Hellstrike missiles with:
 - 6 Hunter-killer missiles+40 pts
 - 6 bombs+40 pts
 - 2 multiple rocket pods+30 pts
- The Vulture may replace its multi-lasers and Hellstrike missiles with:
 - One Twin-linked Punisher Gatling cannon ..+50 pts
- Any aircraft may take any of the following:
 - Flare/chaff launcher+10 pts
 - Armoured cockpit+20 pts
 - Infra-red targeting+5 pts
 - Illum flares+5 pts
 - Distinctive paint scheme/decals+10 pts